



Garpenberg expansion

Capital Markets Day

November 23rd 2012

Peter Richardson

Project Manager, Garpenberg 2.5

BOLIDEN

Environmental performance

- Decreased energy consumption per tonne of produced ore
- Decreased water usage per tonne of produced ore
- Lower noise levels to nearby community
- New environmental permit granted in January 2012



Expansion Garpenberg

- Capex SEK 3.9 billion
- Period 2011 - 2014
- New industrial area
 - New underground facilities
 - New concentrator
 - New infrastructure
- From 1.4 to 2.5 mt of ore/year
- Ramp-up, 2 mt/year 2014 to full production end 2015
- Average grades in mineral reserve
 - Zinc 5.1 %
 - Lead 2.0 %
 - Silver 144 g/t
- Good geological potential

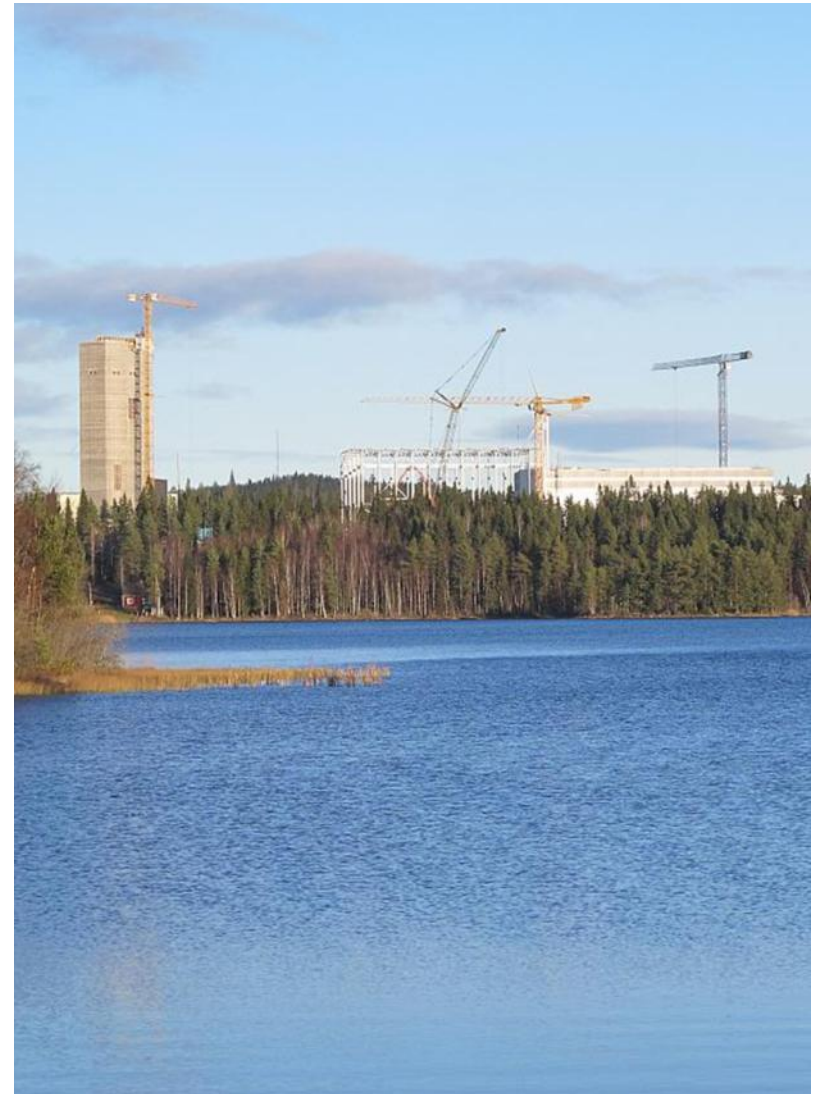

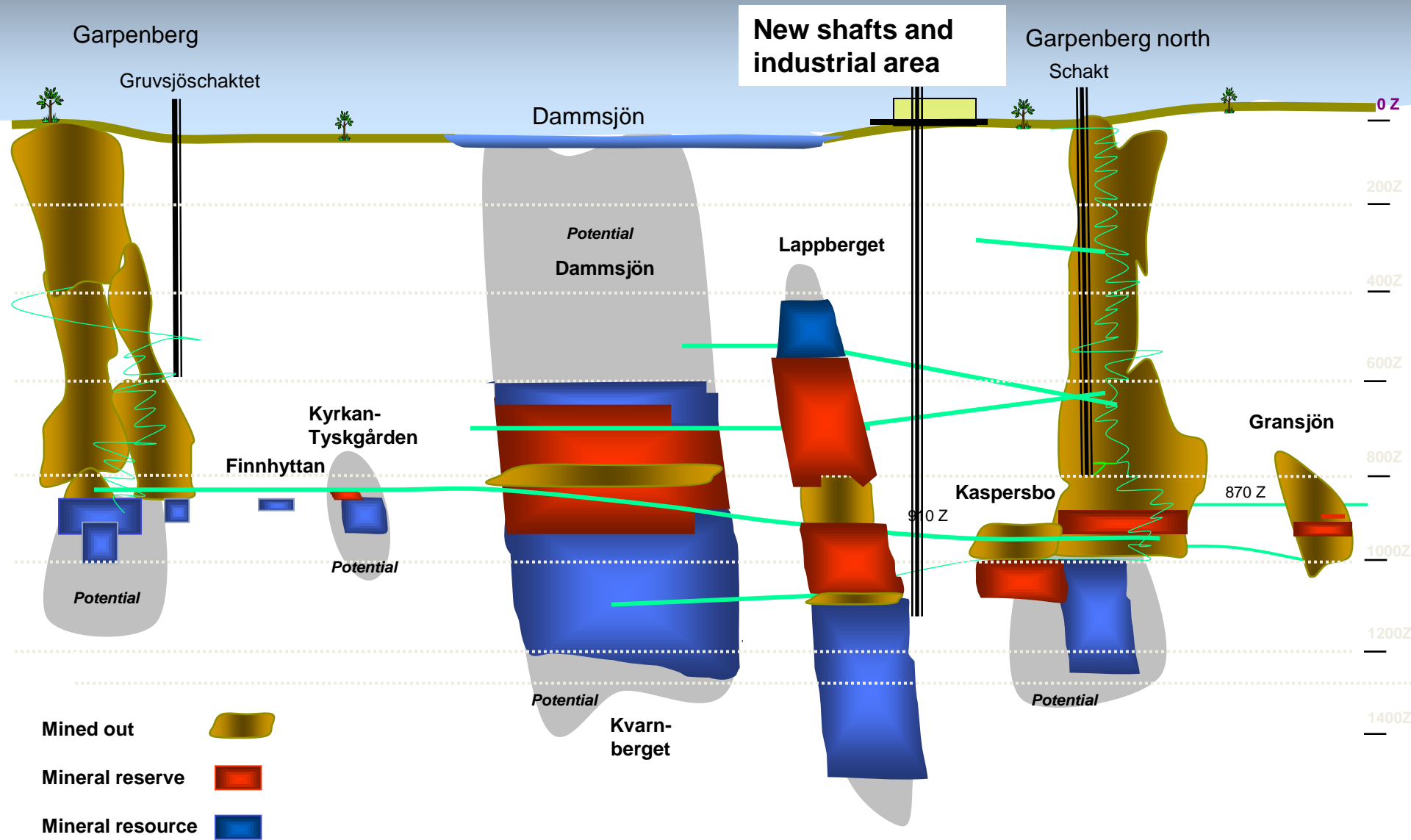

Underground facilities

- Production shaft
- Personnel shaft
- Ventilation shafts
- Crushing stations
- Ore handling system
- Pumpstations

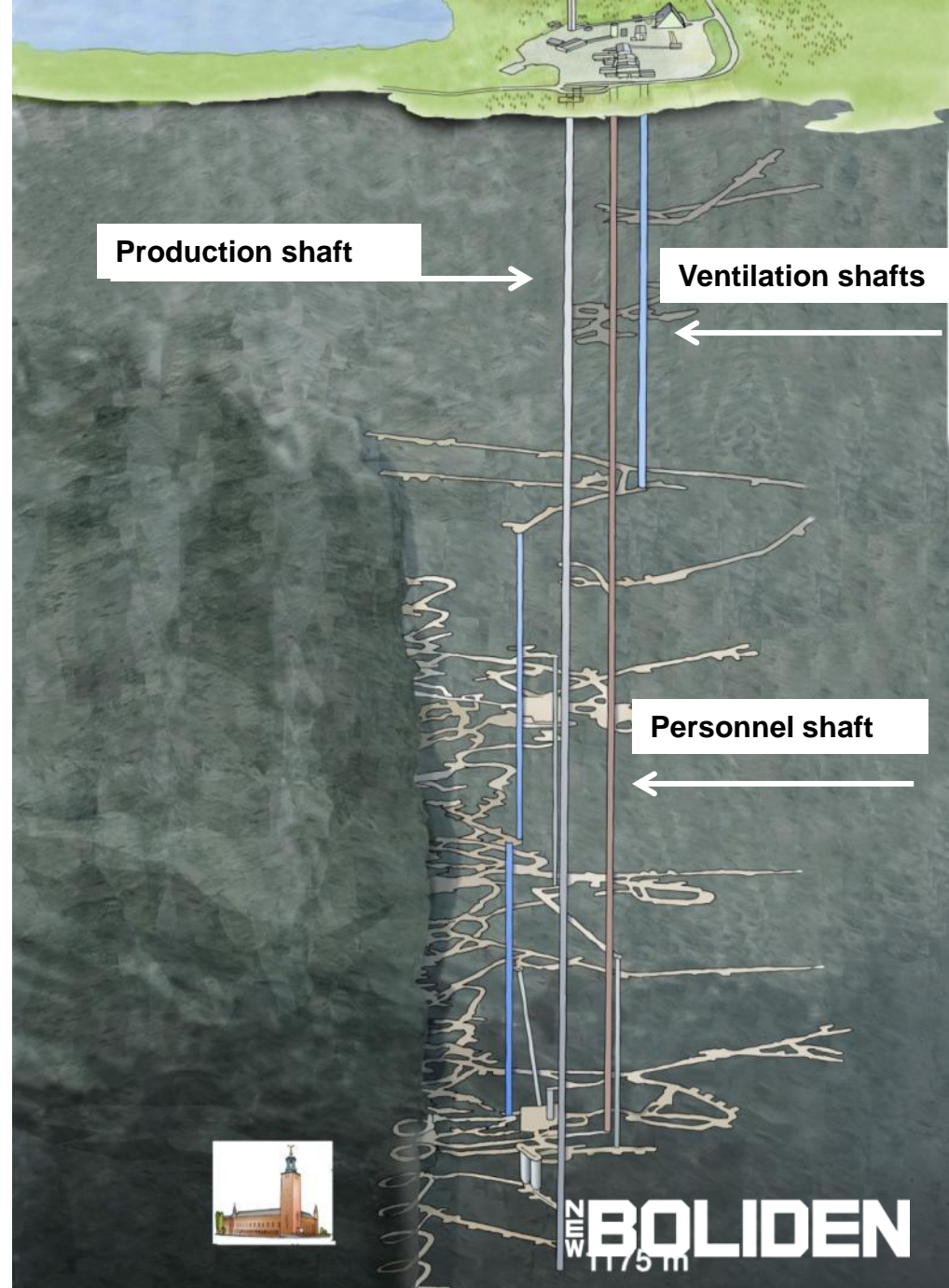

Shafts - raise boring



Production shaft – slashing to 6,5 meter



BOLIDEN

Personnel shaft – internal mountings



BOLIDEN

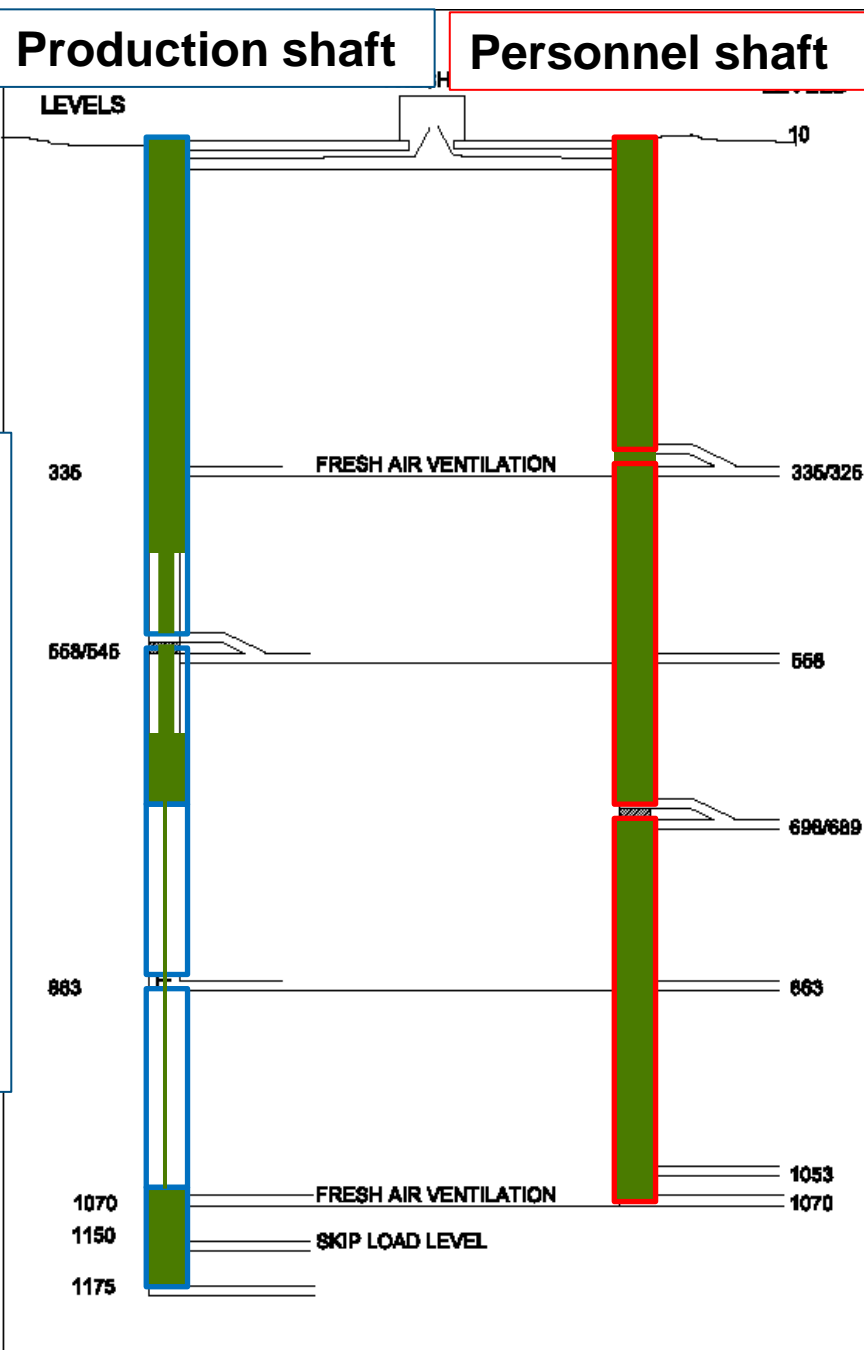

**Depth 1,175 meter
Diameter 6.5 meter**

**Stage 1 – drilled to
3,5 meter.
Slashing ongoing
to 6,5 meter**

**Stage 2 – drilling
ongoing to 5
meter, slashing to
6,5 meter**

**Depth 1070 meter
Diameter 4,5 meter**

**Stage 3 –
mounting of
internal fixtures
ongoing**

Crushing and loading station

At 1 100/1 1150 meters below ground

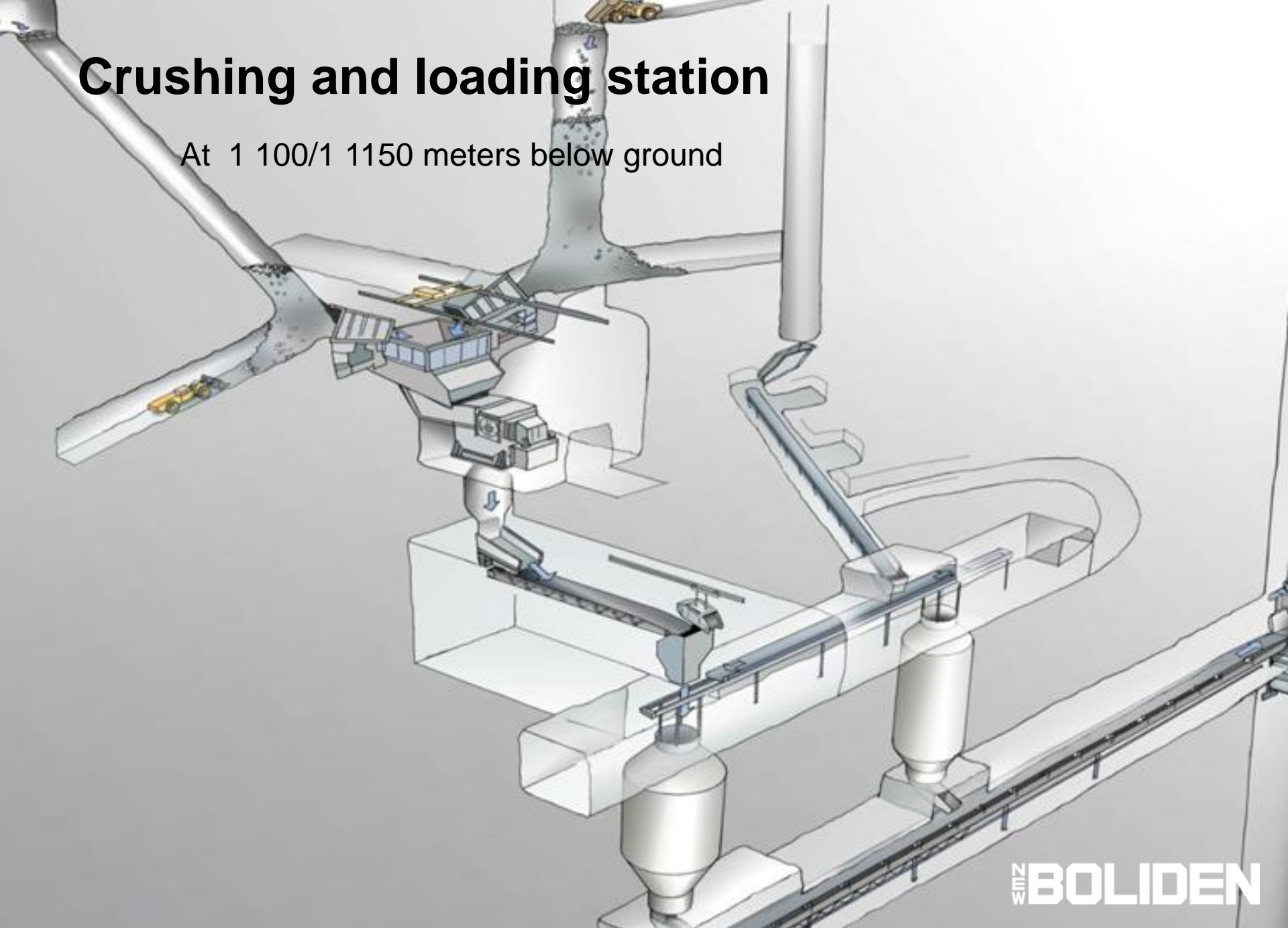

Crushing station 1087



BOLIDEN

Ore handling system – feeder under pass



WIMZ **BOLIDEN**

New industrial area

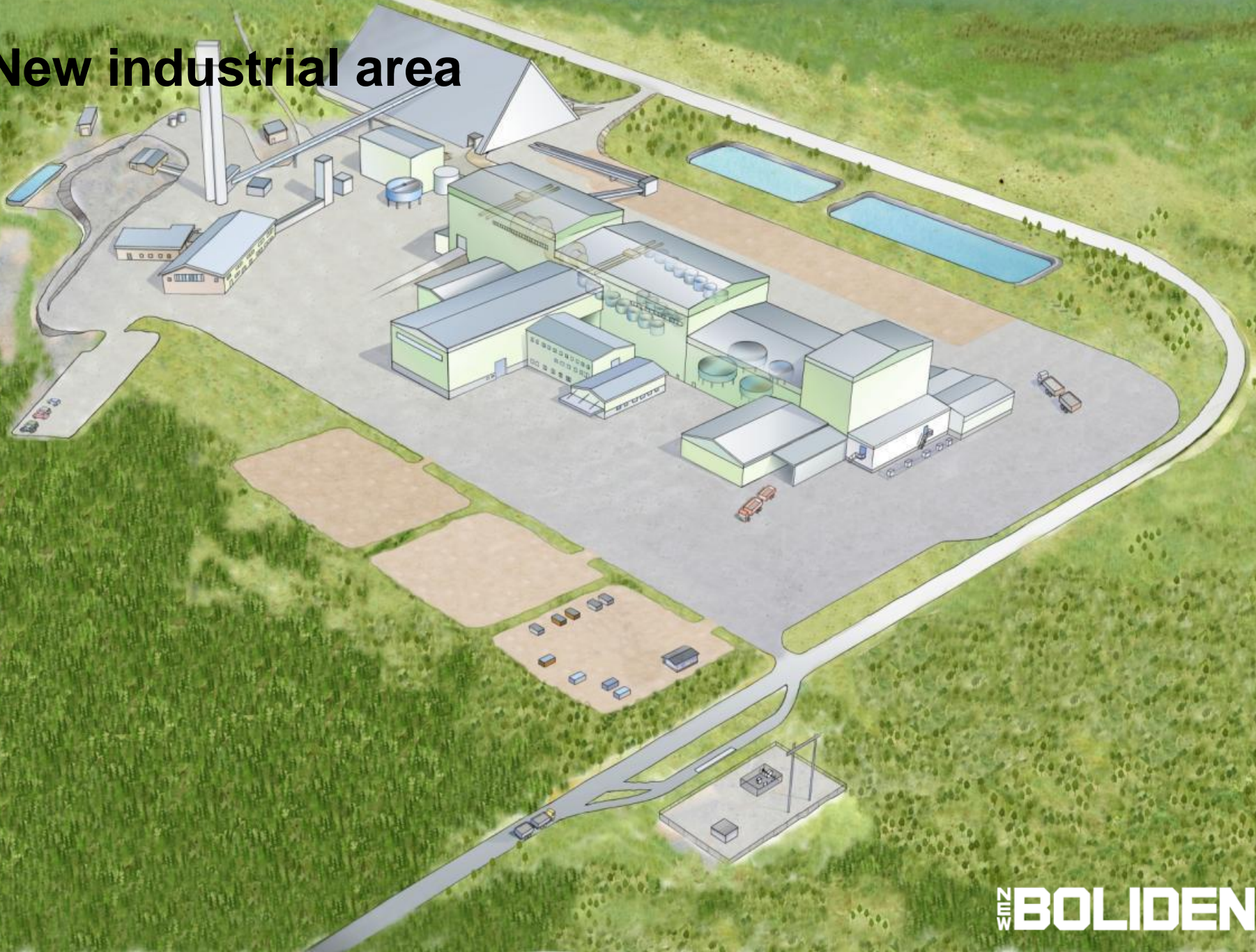

WML **BOLIDEN**

Head frames for production and personnel shaft



Mine ventilation



Ore storage



Concentrator

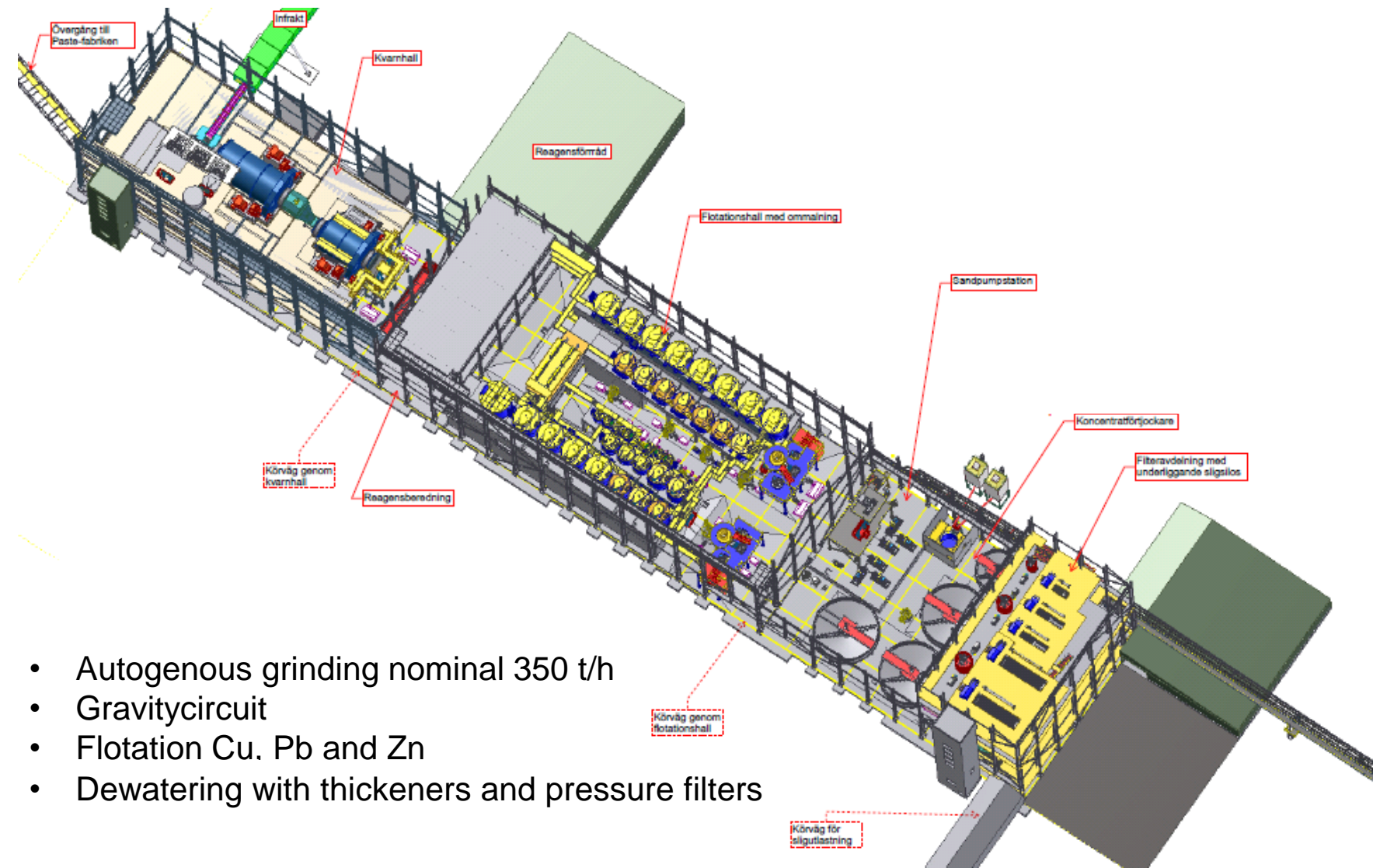

- Autogenous grinding nominal 350 t/h
- Gravity circuit
- Flotation Cu, Pb and Zn
- Dewatering with thickeners and pressure filters

Concentrator



Concentrator - flotation



Aitik 36 vs Garpenberg 2.5

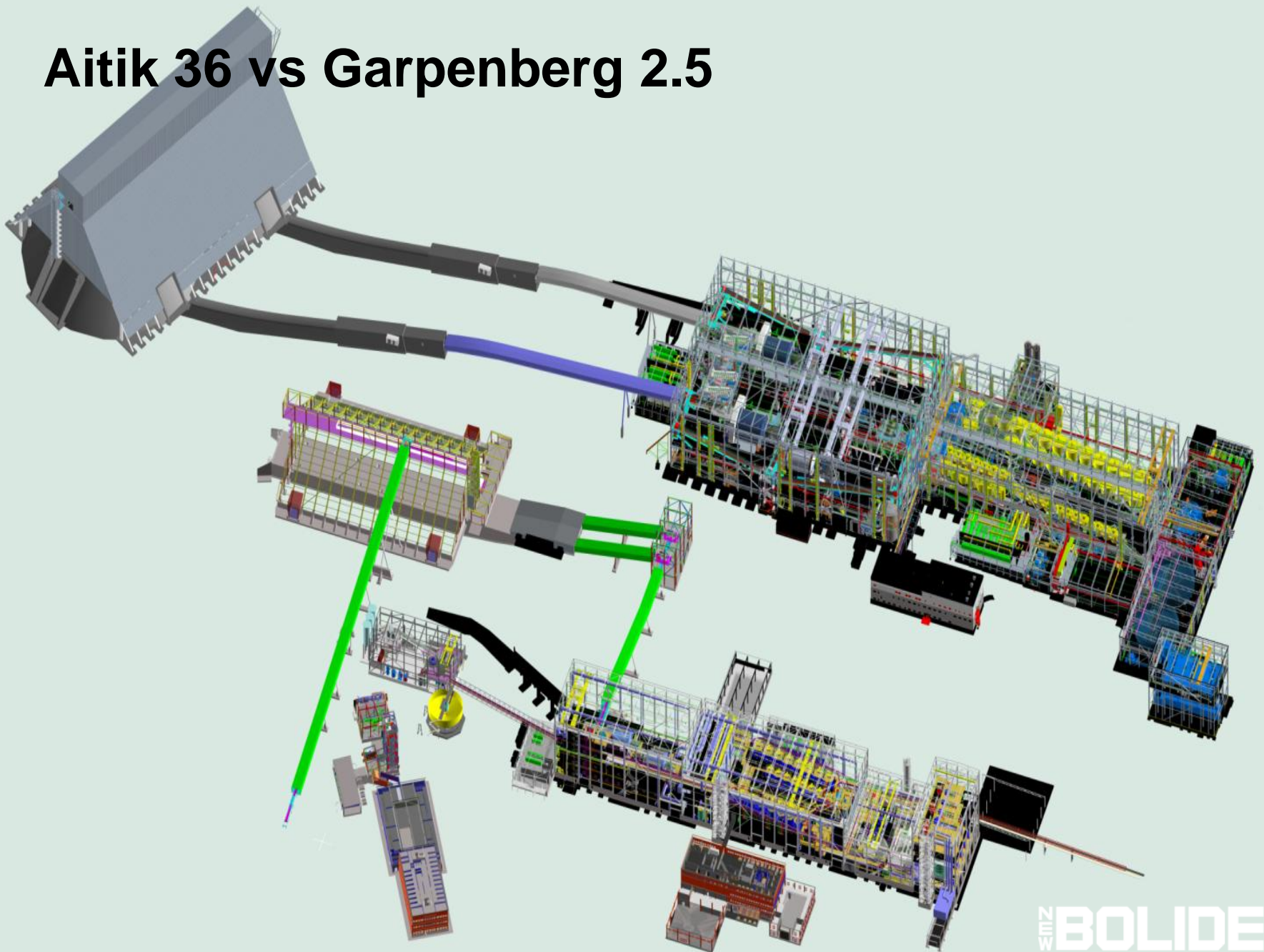

Conclusion

- Nearly doubling of production
- Lower production cost per tonne of ore
- Long life of mine in spite of higher production
- Geological potential high
- Project on plan



Metals for modern life

