



# E-scrap fundamentals

Capital Markets Day  
November 22nd 2012

Roger Sundqvist  
General Manager, Boliden Rönnskär

**BOLIDEN**



# Total feed to Rönnskär

## Normal year, including e-kaldo plant

- Copper Concentrates
  - 650,000 tonnes
- Lead Concentrates
  - 30,000 tonnes
- Steelmill Dust (EAF)
  - 20,000 tonnes
- Copper/Zinc Residues
  - 60,000 tonnes
- E-materials (e-scrap+other)
  - 120,000 tonnes
- Copper Scrap
  - 25,000 tonnes



# The value chain for electrical and electronic waste

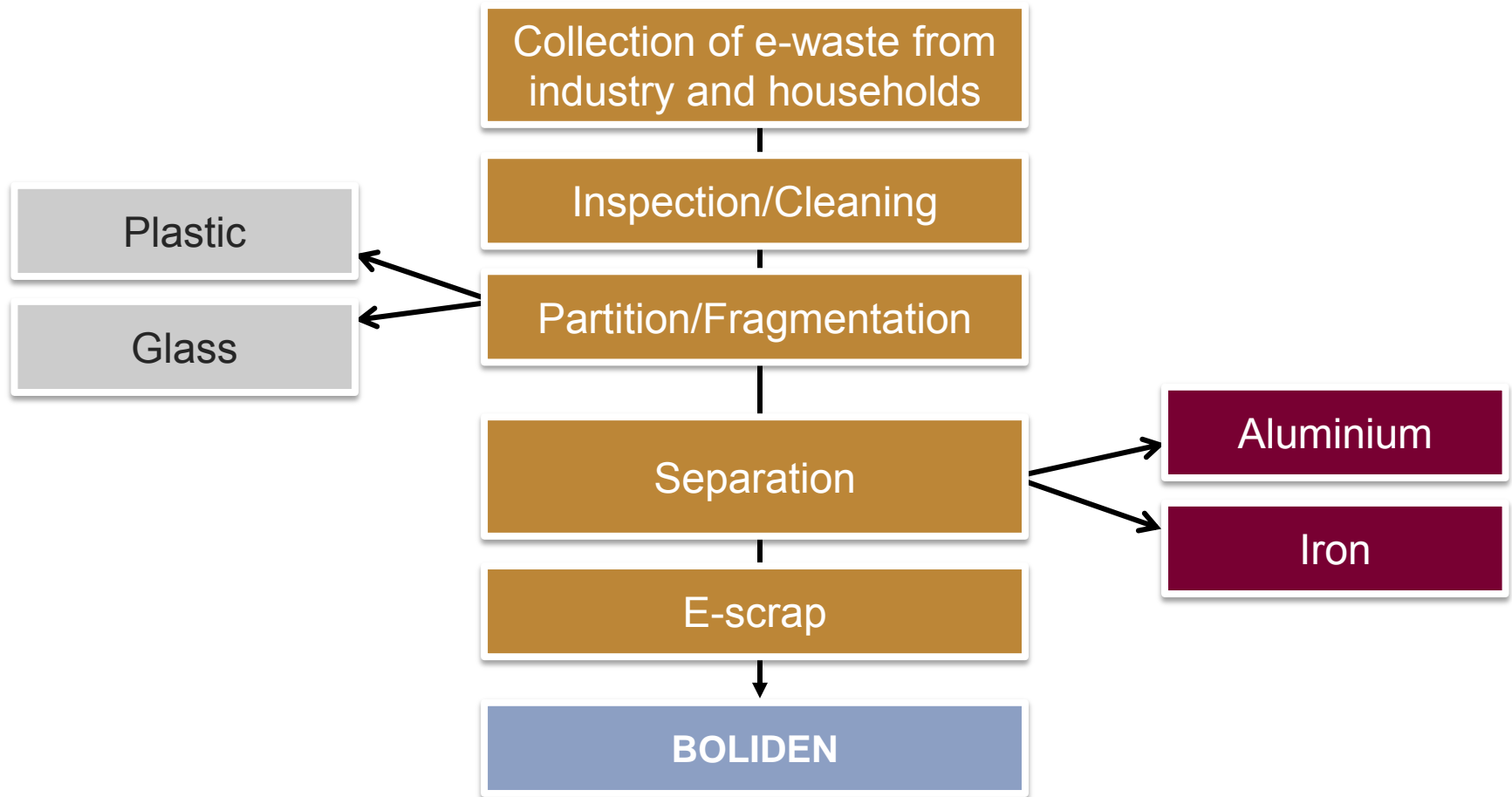

# E-scrap smelting vs potential

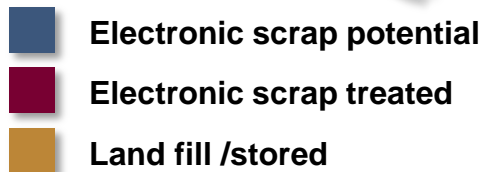
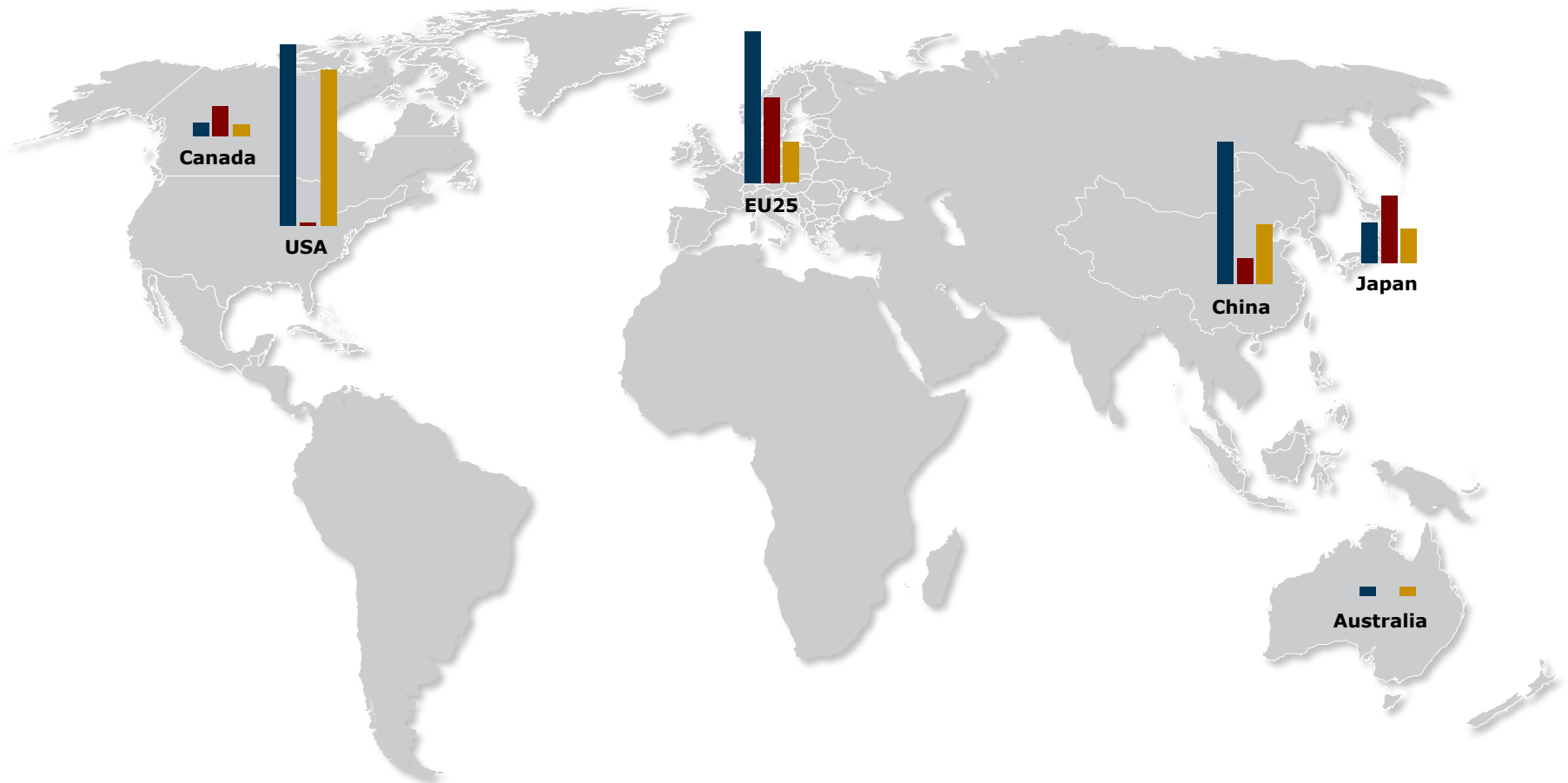

# Sourcing Rönnskär



Europe excl Scandinavia:	70% of volume
Scandinavia:	20% “-
North America:	5% “-
Other:	5% “-

# Main types of e-materials treated at Rönnskär

## E-scrap

- 10 – 30% copper
- 50 – 500 g/t gold
- 200 – 2,000 g/t silver
- Small amounts of palladium
- 10 – 30% plastic



## E-granules

- >30% copper
- 10 – 80 g/t gold
- 200 – 1,000 g/t silver
- Small amounts of palladium
- 1 – 10% plastic



## Alloys

- >60% copper
- 0 – 1,000 g/t gold
- 0 – 5% silver
- <1% plastic



# Method for price-setting

- Similar to concentrate but terms not transparent for e-scrap
- Contracts negotiated separately
- Boliden's revenue is based on TC/RC and free metals.





# Total capacity of 120,000 tonnes of e-scrap

- Lead kaldo plant

- E-scrap smelting since 1980
- Operated in campaigns
- E-scrap smelting, black copper further refined in main copper flow
- Lead smelting, crude lead further refined in lead refinery



- E-kaldo plant

- In operation since January 2012
- Continuous e-scrap smelting
- Black copper further refined in main copper flow



**BOLIDEN**

# Expansion in short

- Increased capacity for smelting of e-scrap to 120,000 tpa – an increase of 75,000 tonnes
- 1.3 bn SEK investment in equipment for unloading/sampling and an e-kaldo plant
- Pay-back time <4 years
- Project started Q2 2010 and e-Kaldo started production in January 2012
- Increased production of gold, silver and copper
- Best available technology

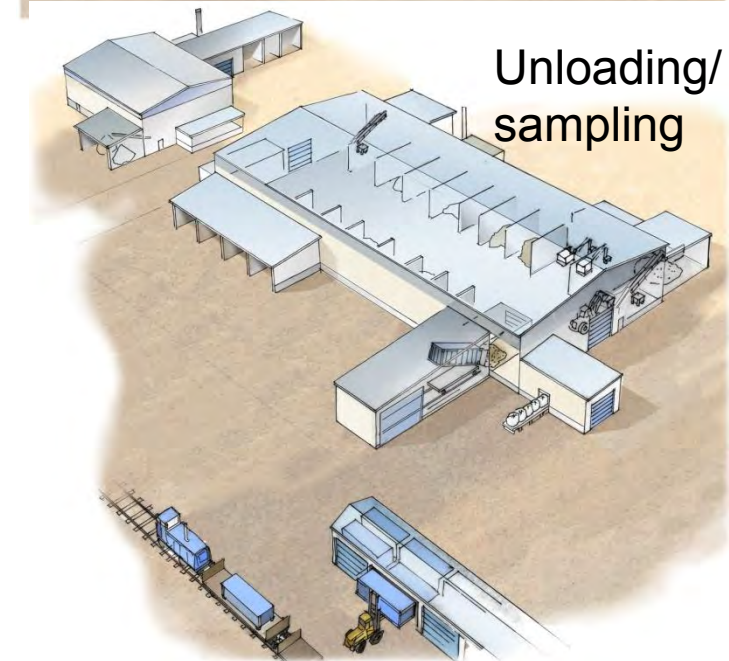
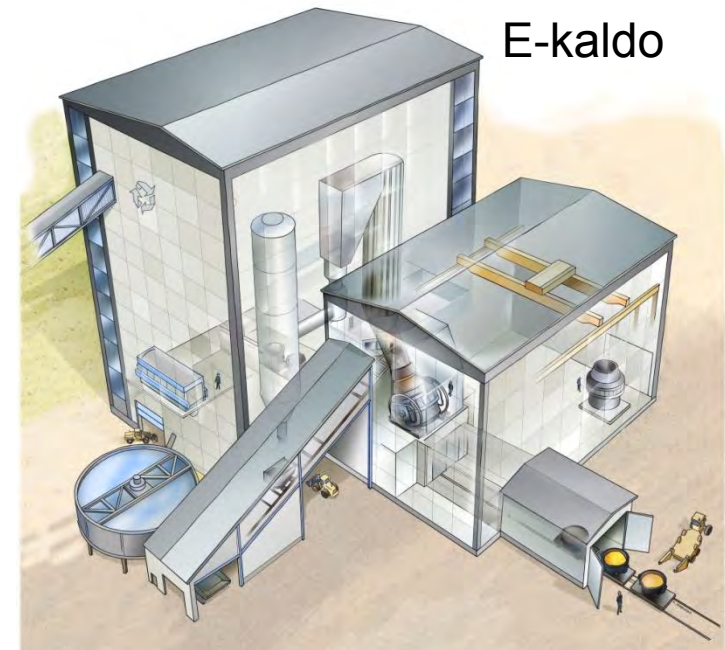

# Sampling

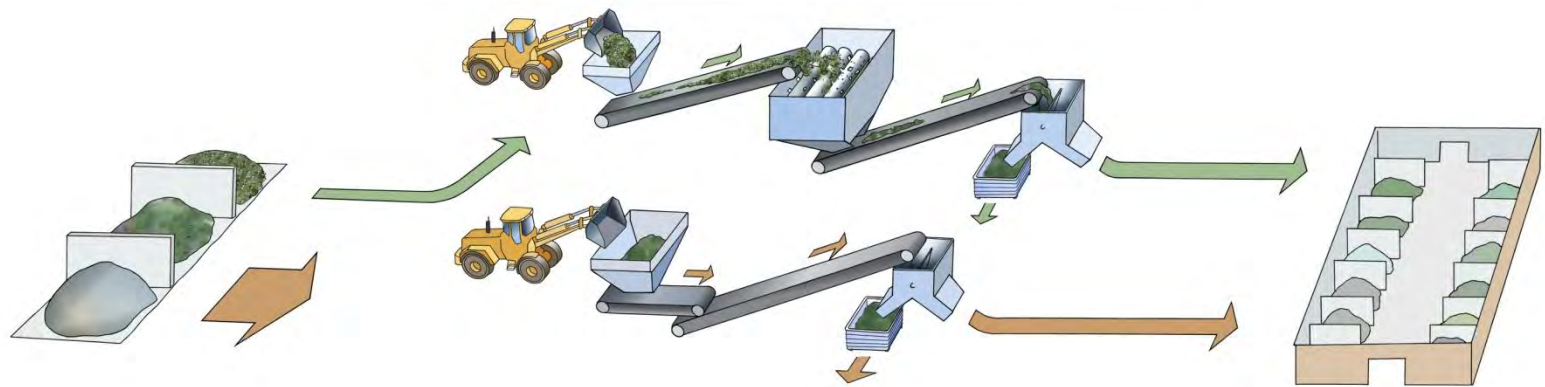
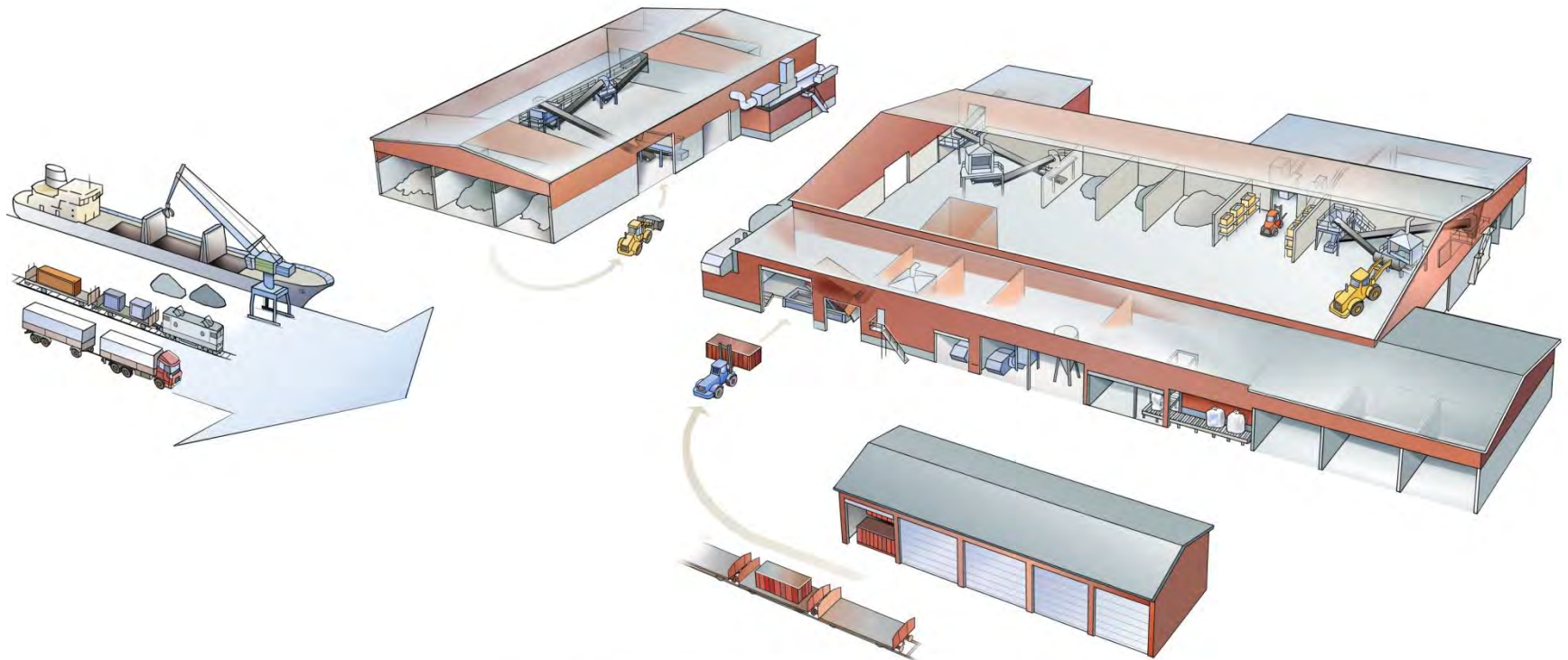

# E-scrap smelting using the Kaldo process

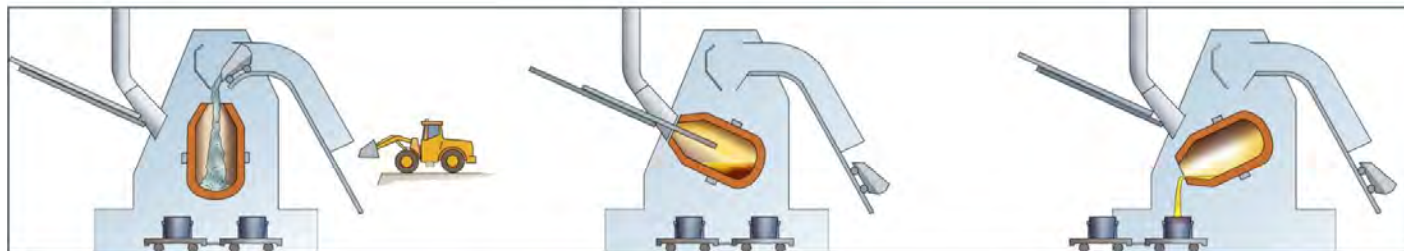
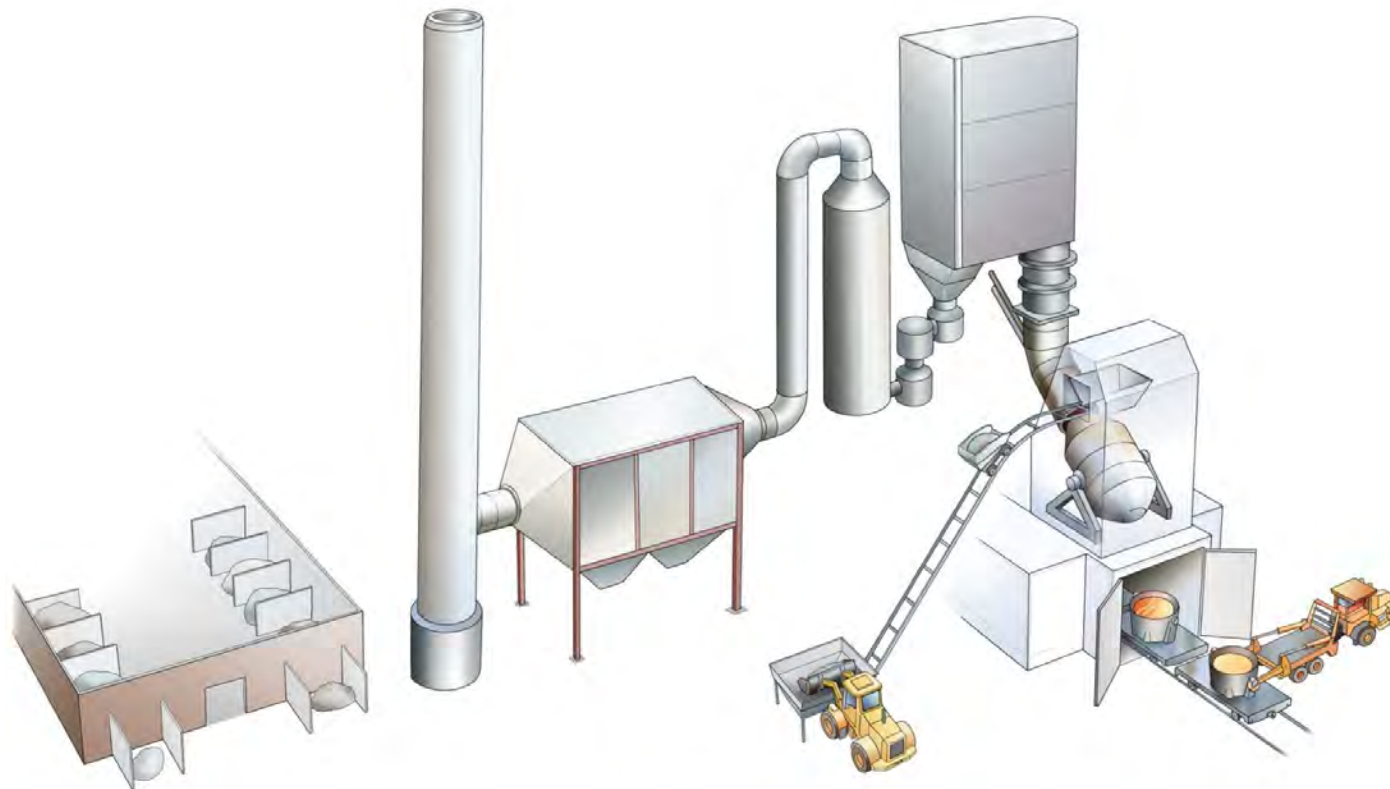

# Competitors

- Europe
  - Aurubis, Hamburg
  - Aurubis, Lünen
  - Umicore, Hoboken
- Rest of the world
  - Xstrata, Canada
  - Dowa, Japan
  - Naoshima, Japan
  - LS Nikko, South Korea
- Biggest “competitors”
  - Exports to China and Africa
  - Waste deposit instead of recycling



# More than 30 years of experience in e-scrap smelting and recycling

E-scrap processed at Rönnskär

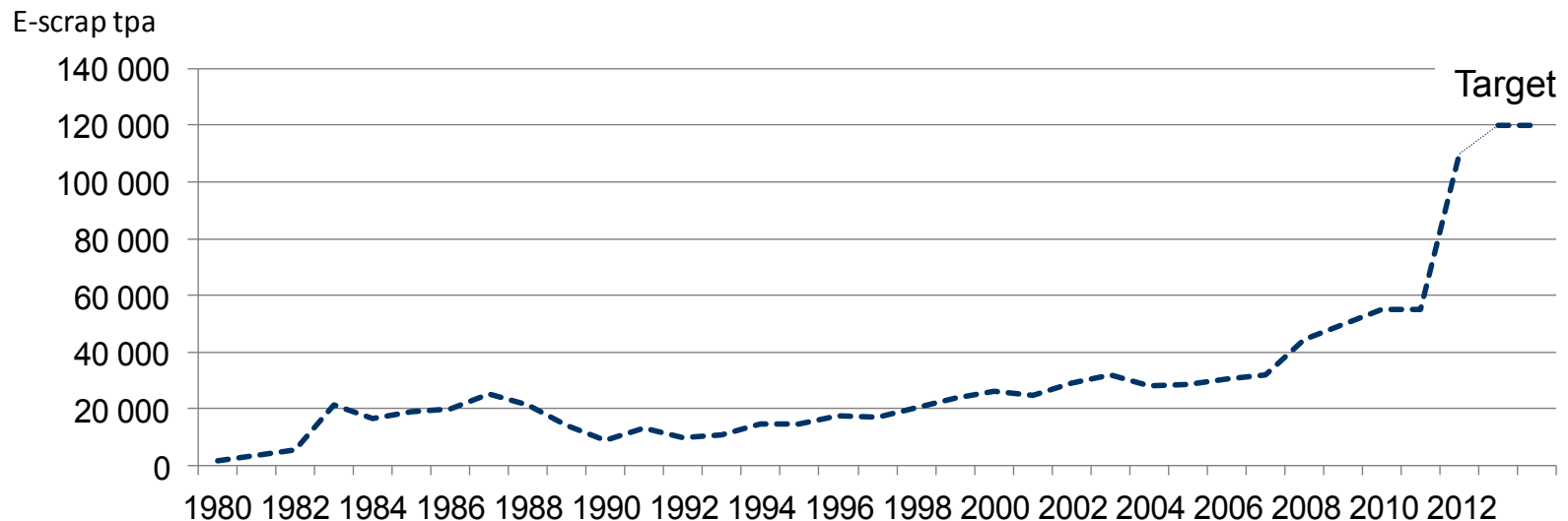

# E-materials Feed, Total Rönnskär 2012

ktonnes

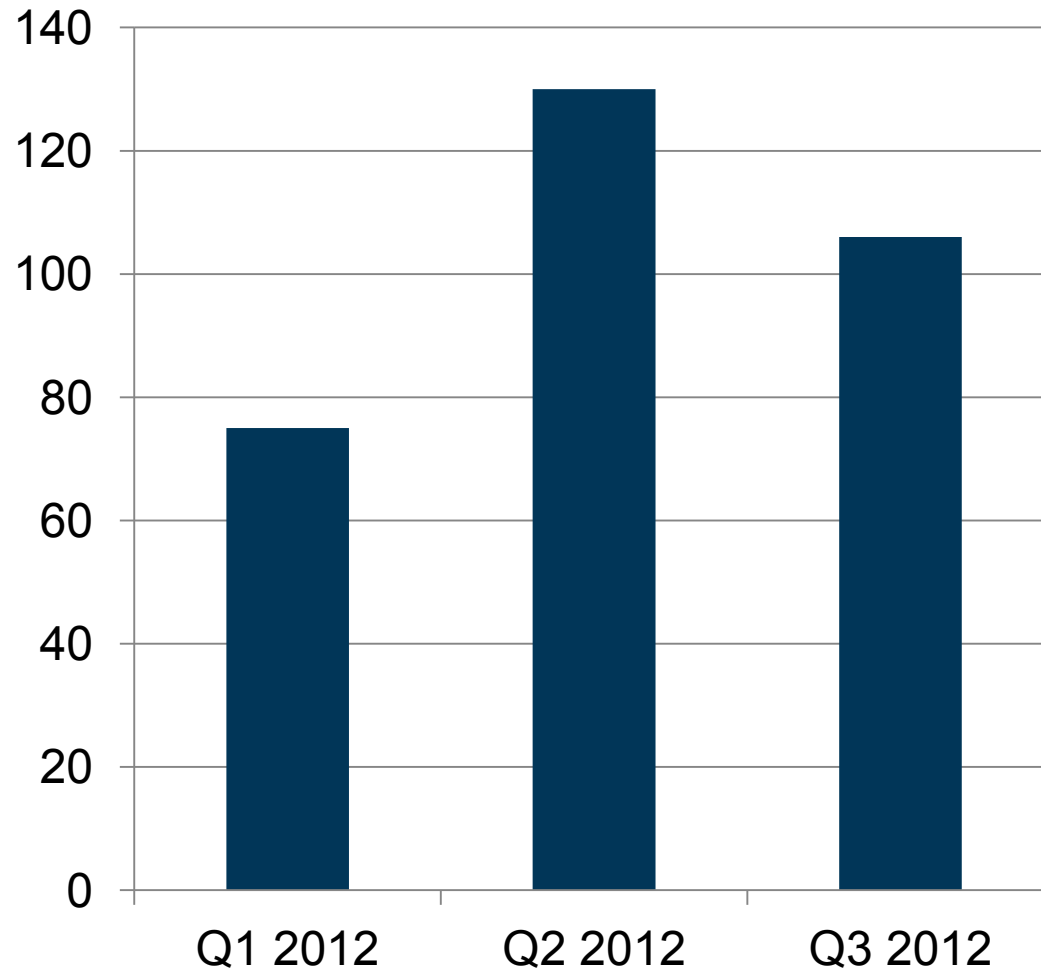

Q3 =  
Higher feed of  
lead concentrates  
than Q2

# Metals for modern life

